

### Features

- +5 dBm Output Level at 75 MHz
- Channel Step Size : 20 kHz
- 2<sup>nd</sup> Harmonic : < -20 dBc
- Spurious Level : < -70 dBc
- Lock Time : < 10 ms
- 17 mA Current Consumption

### Description

The plerow™ PLL synthesizer module was designed for use in wireless and wireline systems in a wide range of frequency from 50 MHz to 6 GHz. ASB's PLL provides exceptionally low spurious and phase noise performance with fast locking time and low current consumption. All products are available in a surface-mount type package.

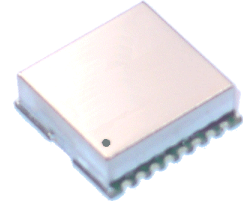

### Specifications

Parameter	Unit	Min.	Typical	Max.
Frequency Range	MHz	70	75	80
Output Power	dBm	4	5	6
Supply Voltage	V	4.7	5.0	5.3
Current Consumption	mA		17	30
Channel Step Size	kHz		20	
2 <sup>nd</sup> Harmonics	dBc		-23	-20
Spurious Level	dBc		-78	-70
Lock Time	ms		3	10
Reference Frequency	MHz		10	
Reference Input Level	dBm	-5	0	5
Phase Noise (C / N)				
@ 10 kHz	dBc/Hz	-113	-110	-107
@ 100 kHz	dBc/Hz	-124	-121	-118
Output Impedance	Ω		50	
Operating Temp. Range	°C	-40	25	85
Package Type & Size	mm	SMT, 19.0W×19.0L×5.8H		

1) Measurement conditions are as follows: T = 25°C, V<sub>CC</sub> = 5 V, Freq. = 75 MHz, 50 ohm system.

### More Information

Website: [www.asb.co.kr](http://www.asb.co.kr)  
E-mail: [sales@asb.co.kr](mailto:sales@asb.co.kr)

Tel: (82) 42-528-7220  
Fax: (82) 42-528-7222

ASB, Inc., 4<sup>th</sup> Fl. Venture Town  
Bldg, KT HRDC, 367-17  
Goijeong-Dong, Seo-Gu,  
Daejeon, 302-716, Korea

### Outline Drawing

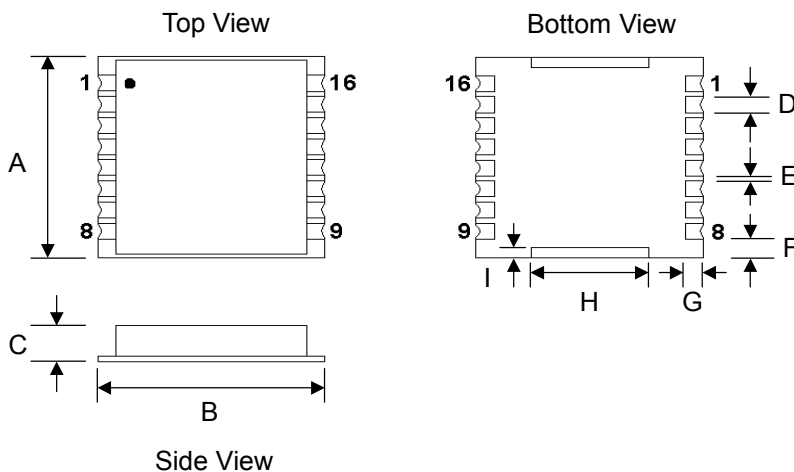

Pin Configuration	
1	CLOCK
2	DATA
3	ENABLE
4	OSC IN
9	VCC (VCO)
13	RF OUT
15	VCP (PLL)
16	LOCK DETECT
Others	Ground

Dimension (mm)	
A	19.0
B	19.0
C	5.8
D	1.5
E	0.5
F	1.75
G	1.35
H	15.0
I	0.9
Tolerance: ± 0.2	